

RU

GB

INSTALLATION MANUAL
SKID PLATE FOR ENGINE BAY and TRANSMISSION CASE



Mercedes-Benz V-Klass (2,2 CDI 4WD)

2017 - 

13.4562/13.4563

25/01/21

1/8



(RU) /
(GB) Location/Position Arrow

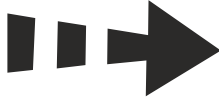

(RU)
(GB) Movement Arrow



(RU)
(GB) Screw Arrow

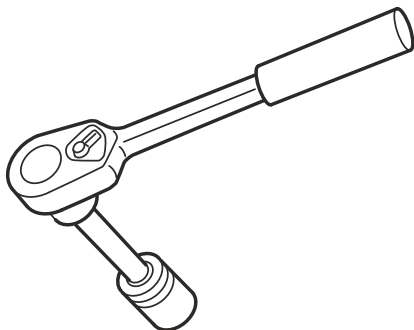
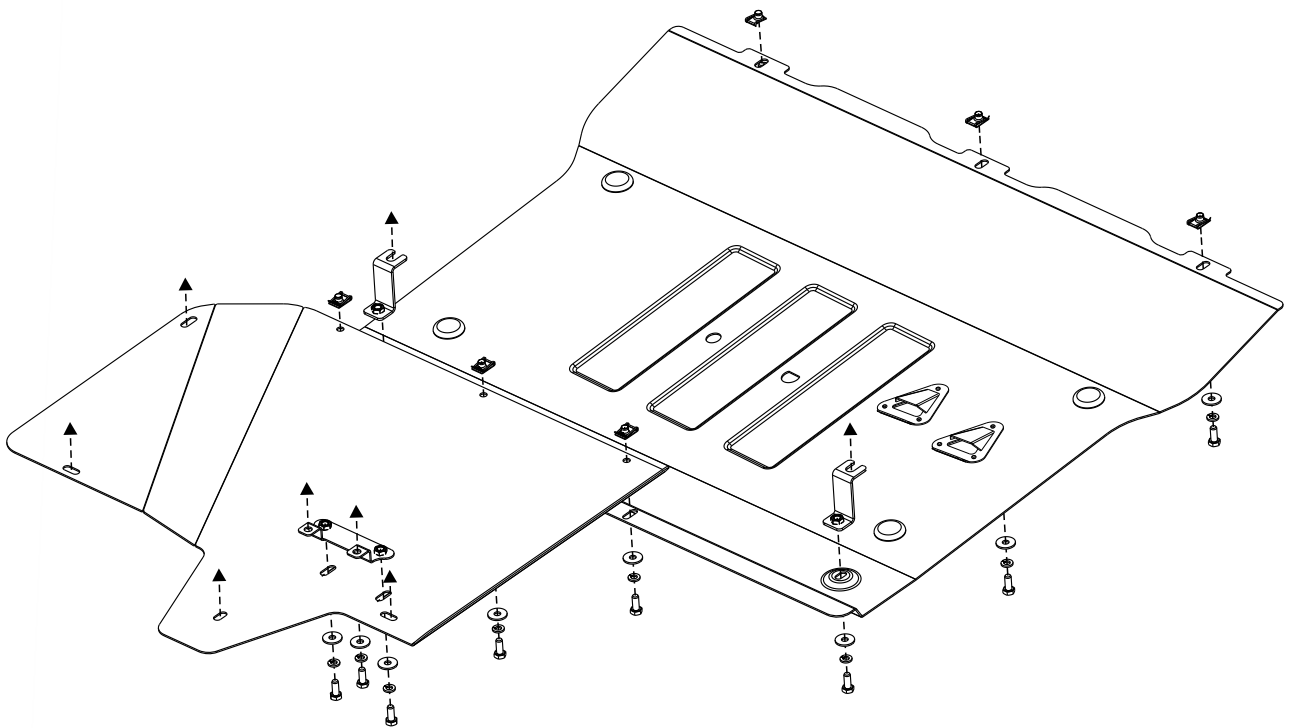

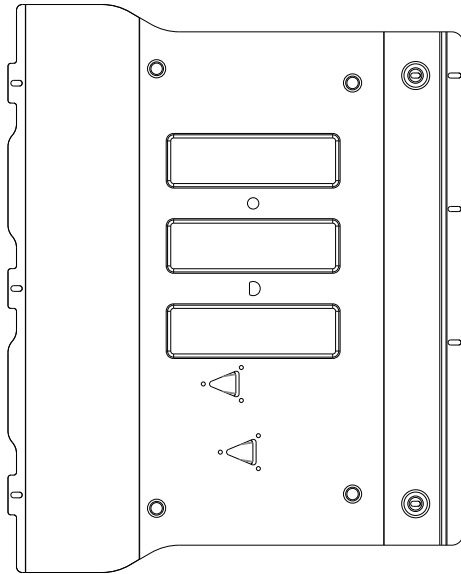
A1

1X

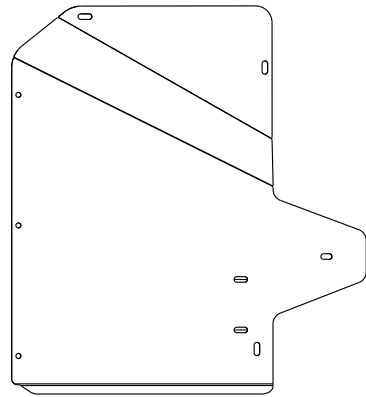
A2

1X

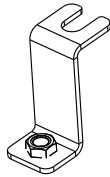
B

2X

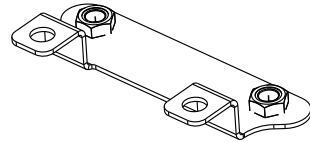
C

1X

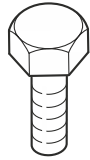
D

M8 30

10X

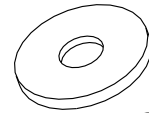
E

Ø8

10X

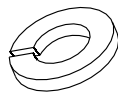
F

Ø8

10X

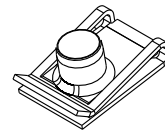
G

6X

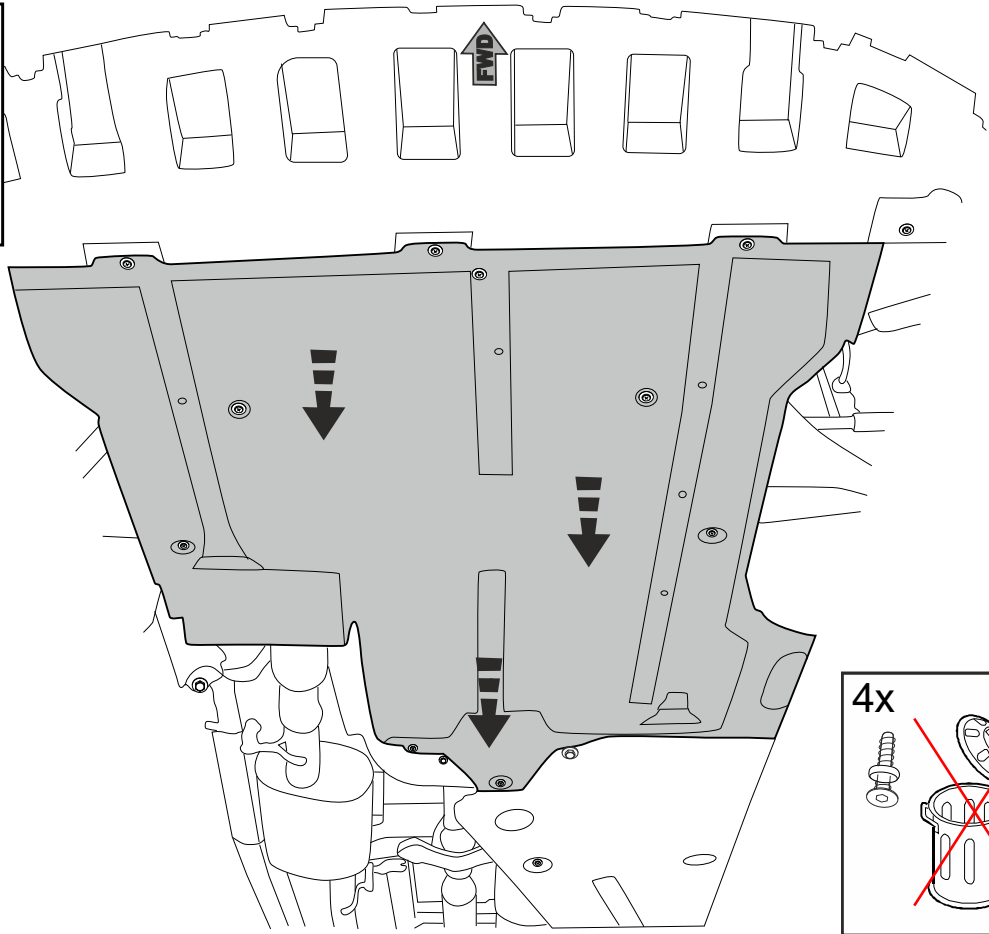
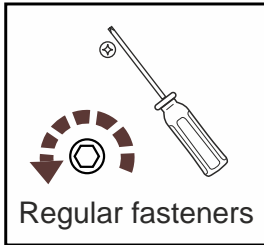

1

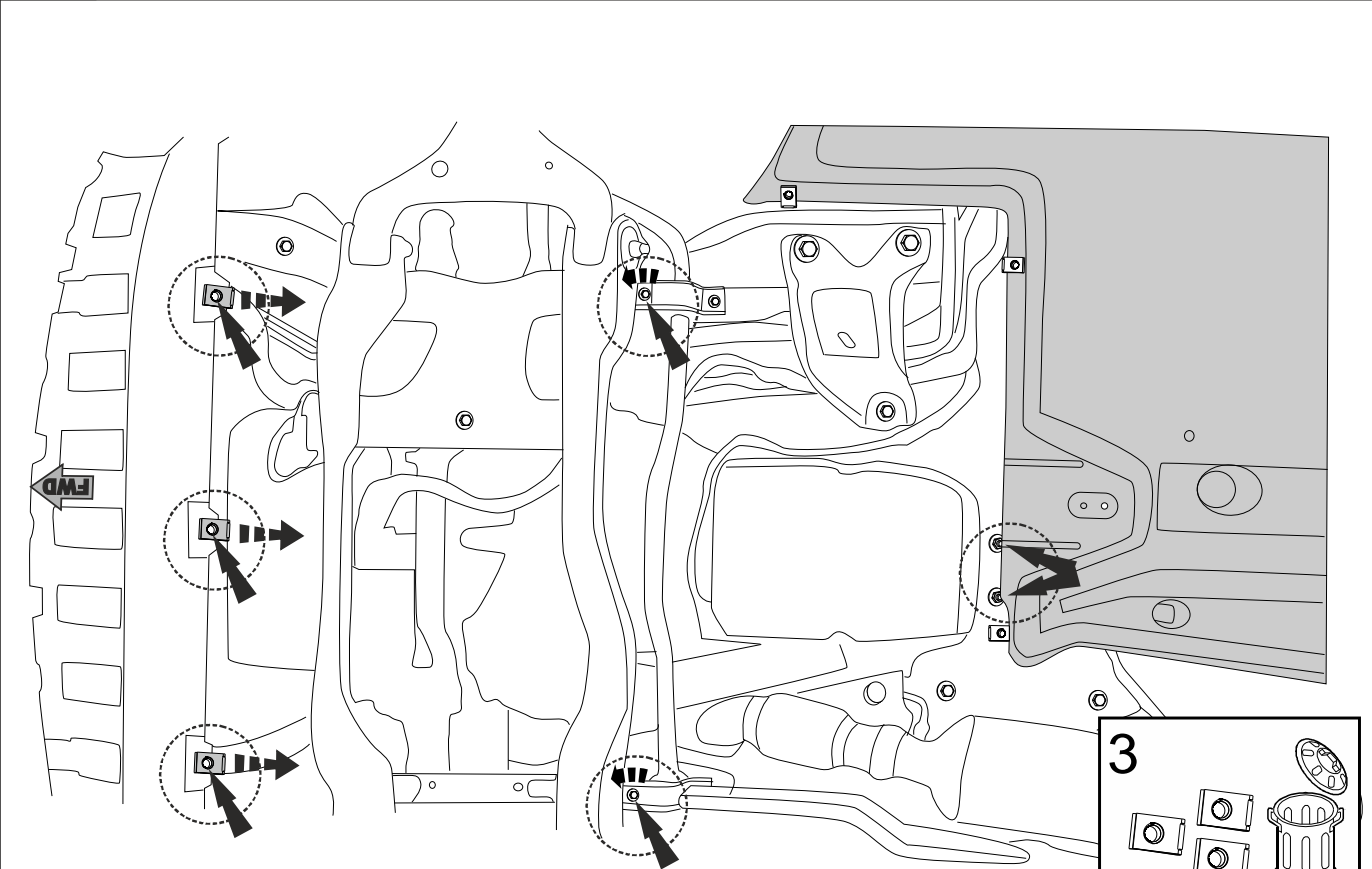
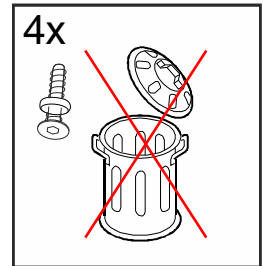

2

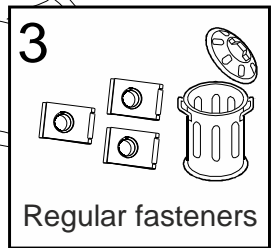

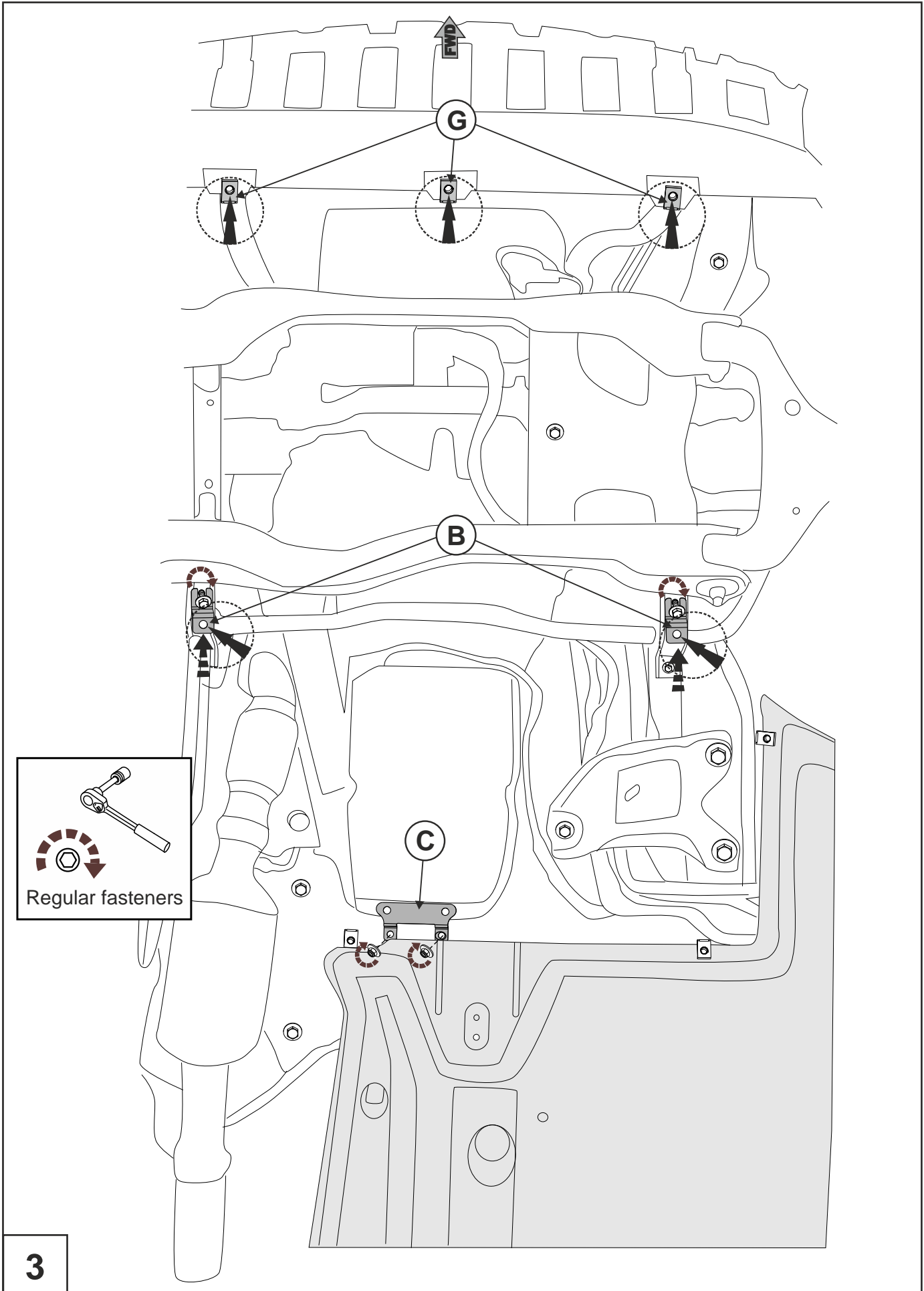

3



13.4562/13.4563

25/01/21

5/8

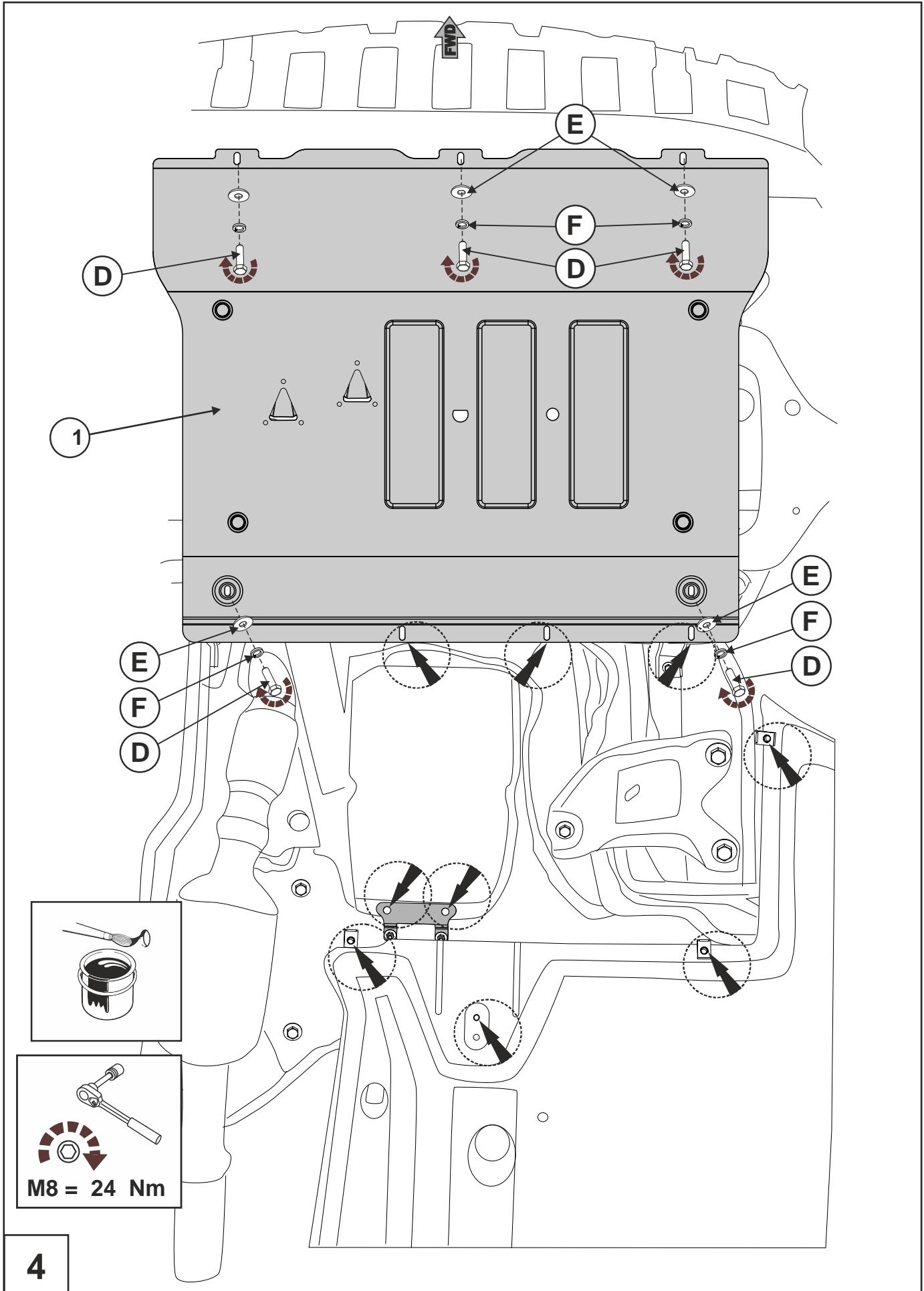

4

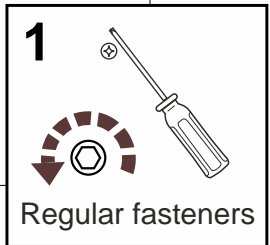
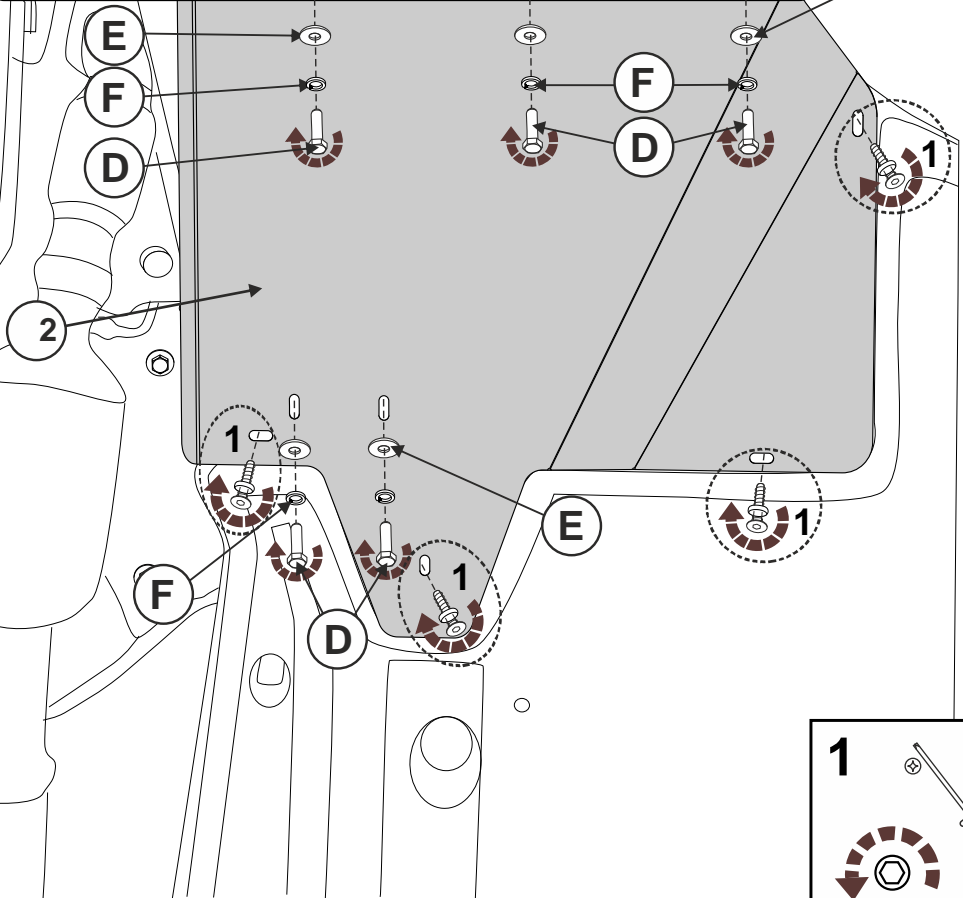
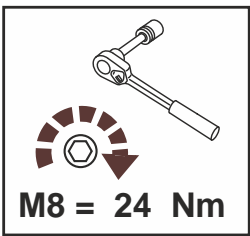
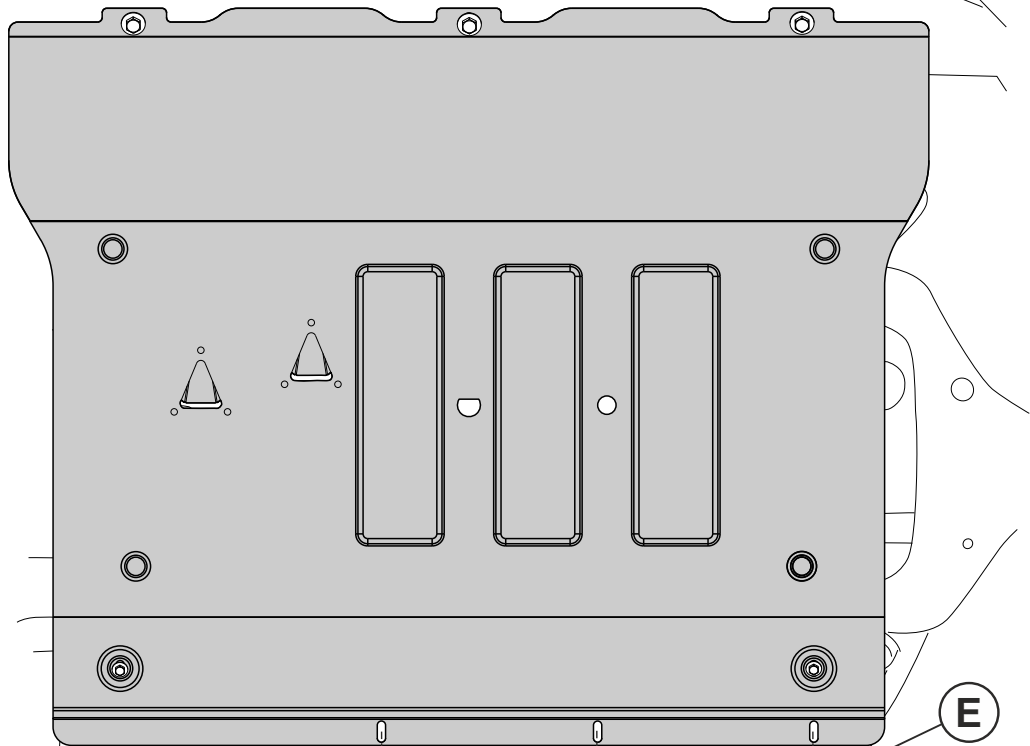
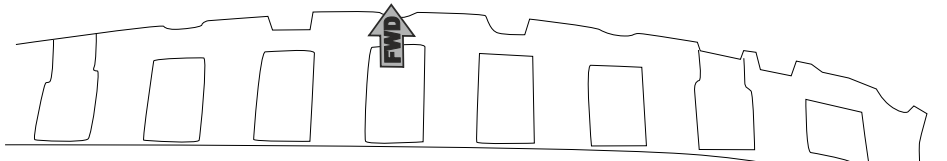

5

